

LONDRA, VIENA

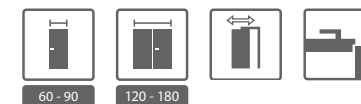

Uși clasice cù bun gust

Modele clasice, elegante și cu un standard ridicat de calitate, așa se caracterizează finisajele ușilor.



VIENA, grilă mare, plină, Alb

CULORI DISPONIBILE

Vopsea Ecologica ★★

Alb

Finisaj PVC ★★★★★



INFORMAȚII TEHNICE

CONSTRUCȚIA CANATULUI

Rama și miezul canaturilor de ușă sunt acoperite pe ambele fețe cu plăci profilate de HDF.

ACCESORII INCLUSE ÎN PREȚUL CANATULUI

- Două balamale standard cu știft, posibilitatea de a comanda balamale PRIME – cost suplimentar
- Broască cu cheie simplă, cu blocare pentru uși de baie sau pregătire pentru cilindru
- Geam „chinchilla”
- Mâner rotund pentru uși glisante

TOCUL

Pentru uși cu falț.

REMARCĂ

- Agreement Tehnic AT016-02/289-2010, CTPC București;
- Agreement Tehnic AT016-02/288-2010, CTPC București.
- Posibilitatea de a alege dimensiunea canaturilor pentru ușile duble.
- * Indisponibil pentru dimensiunea „100” și „110”.

COSTURI SUPLIMENTARE

- grilă, panou de ventilație sau panou cu decupaj pentru ventilație
- pregătire pentru scurtare (max. 60 mm)
- balamele PRIME (pentru tocuri dedicate)
- noua broască cu plăcuța frontală lucioasă (argintiu sau auriu)
- broască specială și mânere laterale (pentru uși glisante)
- capace pentru balamale standard (set pentru o balama)
- mâner cu șild



LONDRA, plină, Alb



LONDRA*
plină

LONDRA*
geam mic

LONDRA*
grilă mică

LONDRA*
grilă mare



VIENA
plină

VIENA
geam mic

VIENA
grilă mică

VIENA
grilă mare



finisaj structură granulară

Dimensiunile de montaj

FALȚUL UȘII

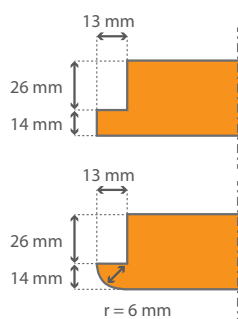

TOC MINIMAX

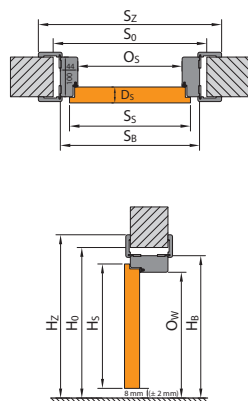

TOC PORTA SYSTEM

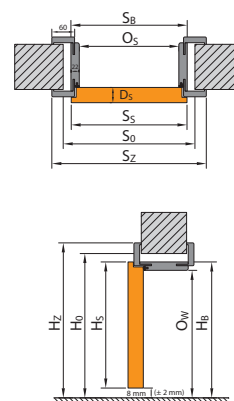

TOC PORTA SYSTEM ELEGANCE

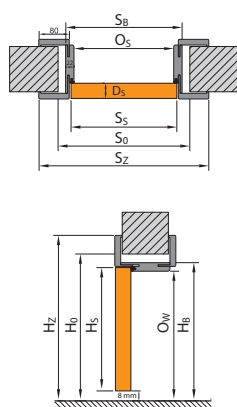

TOC METALIC

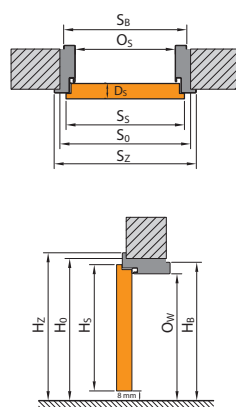

SISTEM DE GLISARE PORTA

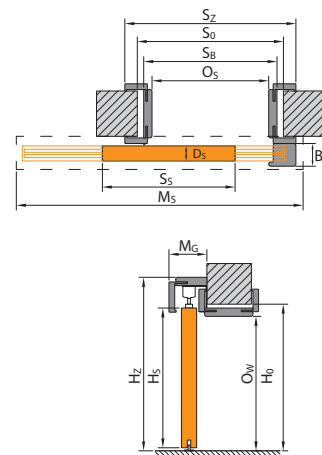

SISTEM DE GLISARE COMPACT

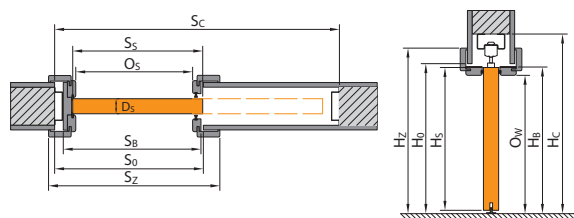

SISTEM DE GLISARE METAL

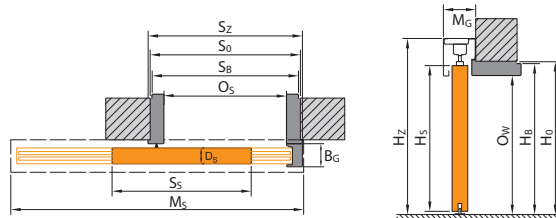

LEGENDĂ

- S_s** lățimea totală a canatului cu falțuri
- H_s** înălțimea canatului de ușă cu falțuri
- D_s** grosimea foi de ușă
- S_o** lățimea golului de perete pregătit pentru montarea tocului
- H_o** înălțimea golului de ușă în perete pregătit pentru montajul tocului, măsurată de la nivelul podelei finisate
- O_s** lățimea golului de trecere (distanța între elementele verticale ale tocului) – în cazul Alfa, Beta, Omega
- O_w** și a ușilor de garderobă, dimensiunea este mai mică cu grosimea
- S_b** ușii poziționată pe balamale

- H_b** înălțimea tocului, dimensiunea fără pervazuri
- S_z** lățimea totală a tocului de ușă, dimensiunea cu pervazuri
- H_z** înălțimea totală a tocului de ușă cu pervazuri
- M_s** lungimea pervazului pentru sistemul de glisare
- M_G** grosimea pervazului pentru sistemul de glisare
- B_G** grosimea panoului de protecție pentru sistemul de glisare
- T_{s/w}** toleranța acceptată privind variația lățimii/inălțimii golului de ușă
- S_c** lățimea golului de zid pentru inserarea casetei metalice
- H_c** înălțimea golului de zid pentru inserarea casetei metalice, măsurată de la nivelul podelei finisate

Dimensiunile ușilor

UȘI DE INTERIOR ȘI TOCURI DIN MDF

TABEL 1

TIP DE TOC	DIM.	S _s	H _s	D _s	S _o	H _o	O _s	O _w	S _b	H _b	S _z	H _z	T _{5/10}
cu toc Minimax 60 mm Minimax 100 mm MDF cu furnir natural	60	644	2030	40	710	2075	602	2016	690	2060	800	2115	+20 / +10
	70	744			810		702		790		900		
	80	844			910		802		890		1000		
	90	944			1010		902		990		1100		
	100	1044			1110		1002		1090		1200		
cu toc Porta SYSTEM / Porta SYSTEM ELEGANCE	60	644 / 618	2030 / 2017	40	680	2060	602	2016	646 / 648	2038 / 2039	746 / 786	2088 / 2108	+20 / +10
	70	744 / 718			780		702		746 / 748		846 / 886		
	80	844 / 818			880		802		846 / 848		946 / 986		
	90	944 / 918			980		902		946 / 948		1046 / 1086		
	100	1044 / 1018			1080		1002		1046 / 1048		1146 / 1186		
	110	1144 / -			1180 / -		1102 / -		1146 / -		1246 / -		
cu toc Villadora MODERN varianta STANDARD 20 / 22	60	618	2017 / 2200	40	680	2060 / 2243	600	2016 / 2199	646	2039 / 2222	787 / 827	2109 / 2312	+20 / +10
	70	718			780		700		746		887 / 927		
	80	818			880		800		846		987 / 1027		
	90	918			980		900		946		1087 / 1127		
	100	1018			1080		1000		1046		1187 / 1227		
cu toc Villadora MODERN varianta PLUS 2.0 / 2.2	60	618	2017 / 2200	40	680	2060 / 2243	600	2016 / 2199	646	2047 / 2230	787 / 827	2229 / 2412	+20 / +10
	70	718			780		700		746		887 / 927		
	80	818			880		800		846		987 / 1027		
	90	918			980		900		946		1087 / 1127		
	100	1018			1080		1000		1046		1187 / 1227		
cu toc Villadora RETRO	60	644	2030	40	680	2060	602	2016	646	2038	789	2110	+20 / +10
	70	744			780		702		746		889		
	80	844			880		802		846		989		
	90	944			980		902		946		1089		
	100	1044			1080		1002		1046		1189		

REMARCĂ: Toleranța pentru dimensiunea S_z și H_z la tocurile finisate cu furnir natural este de -1 mm/+3 mm.

UȘI DE INTERIOR ȘI TOCURI METALICE

TABEL 2

TIP DE TOC	DIM.	S _s	H _s	D _s	S _o	H _o	O _s	O _w	S _b	H _b	S _z	H _z	T _{5/10}
toc DE COLȚ 50 mm	60	644	2030	40	650	2045	596	2016	629	2033	686	2061	±10 / ±5
	70	744			750		696		729		786		
	80	844			850		796		829		886		
	90	944			950		896		929		986		
	100	1044			1050		996		1029		1086		
toc DE COLȚ MARE pentru perete de zidărie	60	644	2030	40	675	2055	596	2016	656	2046	686	2061	±10 / ±5
	70	744			775		696		756		786		
	80	844			875		796		856		886		
	90	944			975		896		956		986		
	100	1044			1075		996		1056		1086		
toc DE COLȚ MARE pentru perete de gips-carton	60	644	2030	40	680	2055	596	2016	656	2046	686	2061	+10 / +5
	70	744			780		696		756		786		
	80	844			880		796		856		886		
	90	944			980		896		956		986		
	100	1044			1080		996		1056		1086		
toc REGLABIL	60	644	2030	40	700	2070	596	2016	680	2058	716	2076	-10 / -5
	70	744			800		696		780		816		
	80	844			900		796		880		916		
	90	944			1000		896		980		1016		
	100	1044			1100		996		1080		1116		
toc reglabil metalic PS „cant dreptunghiular”	60	644	2030	40	700	2070	596	2016	679	2058	736	2086	-10 / -5
	70	744			800		696		779		836		
	80	844			900		796		879		936		
	90	944			1000		896		979		1036		
	100	1044			1100		996		1079		1136		

Porta KMI România și Porta KMI Polonia își rezervă dreptul de a opera modificări privind parametri tehnici, specificațiile produselor și condițiile de garanție extinsă, fără înștiințare prealabilă. Prezentele informații sunt valabile la data apariției acestui material. Informațiile prezentate în edițiile anterioare ale catalogelor Porta, își pierd valabilitatea.

Dimensiunile ușilor

STANDARD CEH SI SLOVAC (ČSN+STN)* / STANDARD GERMAN (DIN)

UȘI DE INTERIOR ȘI TOCURI DIN MDF

TABEL 7

	DIM.	S _s	H _s	D _s	S _o	H _o	O _s	O _w	S _B	H _B	S _Z	H _Z	T _{siw}
Minimax 60 mm Minimax 80 mm Minimax 100 mm Rondo 100 mm MDF cu furnir natural	60	648/610	1985	40	715/680	2030	606/568	1971	694/657	2015	804/767	2070	+20 / +10
	70	748/735			815/805		706/693		794/782		904/892		
	80	848/860			915/930		806/818		894/907		1004/1017		
	90	948/985			1015/1055		906/943		994/1032		1104/1142		
	100	1048/-			1115/-		1006/-		1094/-		1204/-		
cu toc reglabil Porta SYSTEM	60	648/610	1985	40	685/650	2015	606/568	1971	650/613	1993	750/713	2043	+20 / +10
	70	748/735			785/775		706/693		750/738		850/838		
	80	848/860			885/900		806/818		850/863		950/963		
	90	948/985			985/1025		906/943		950/988		1050/1088		
	100	1048/-			1085/-		1006/-		1050/-		1150/-		
cu toc reglabil Porta SYSTEM ELEGANCE	60	622/584	1972	40	684/640	2015	604/566	1971	650/606	1994	791/747	2064	+20 / +10
	70	722/709			784/765		704/691		750/731		891/872		
	80	822/834			884/890		804/816		850/856		991/997		
	90	922/959			984/1015		904/941		950/981		1091/1122		
	100	1022/-			1084/-		1004/-		1050/-		1191/-		
cu toc de colț mic	60	648/610	1985	40	654/615	1995	600/561	1968	633/594	1985	690/651	2013	±10 / ±5
	70	748/735			754/740		700/686		733/719		790/776		
	80	848/860			854/865		800/811		833/844		890/901		
	90	948/985			954/990		900/936		933/969		990/1026		
	100	1048/-			1054/-		1000/-		1033/-		1090/-		
toc METALIC 50 mm	60	648/610	1985	40	680/640	2010	600/561	1968	660/621	1998	690/651	2013	±10 / ±5
	70	748/735			780/765		700/686		760/746		790/776		
	80	848/860			880/890		800/811		860/871		890/901		
	90	948/985			980/1015		900/936		960/996		990/1026		
	100	1048/-			1080/-		1000/-		1060/-		1090/-		
toc METALIC 100 mm	60	648/610	1985	40	704/665	2020	600/561	1968	684/645	2010	720/681	2028	-10 / -5
	70	748/735			804/790		700/686		784/770		820/806		
	80	848/860			904/915		800/811		884/895		920/931		
	90	948/985			1004/1040		900/936		984/1020		1020/1056		
	100	1048/-			1104/-		1000/-		1084/-		1120/-		
cu toc REGLABIL	60	648/584	1985	40	705/665	2020	600/561	1969	683/644	2011	740/701	2039	-10/-5
	70	748/709			805/790		700/686		783/769		840/826		
	80	848/959			905/915		800/811		883/894		940/951		
	90	948/1084			1005/1040		900/936		983/1019		1040/1076		
	100	1048/-			1105/-		1000/-		1083/-		1140/-		

UȘI DE INTERIOR PENTRU INTRARE ÎN APARTAMENT

TABEL 8

	DIM.	S _s	H _s	D _s	S _o	H _o	O _s	O _w	S _B	H _B	S _Z	H _Z	T _{siw}
AGAT, OPAL, QUARTZ, GRANITE	80	848/860	1985	40/44	880/890	2010	800/811	1968	860/871	1998	910/921	2023	±10 / ±5
	90	948/985		44/48	980/1015		900/936		960/996				
	100	1048/-		45/47	1080/-		1000/-		1060/-				











SISTEME DE GLISARE, CANATURI GLISANTE, CANATURI PLIABILE









TABEL 9

	DIM.	S _s	H _s	D _s	S _o	H _o	O _s	O _w	H _Z	M _s	M _G	B _G	T _{siw}
Sistem de glisare PORTA	60	644	1985	40	680	2015	606/568	1971	2074	1363	98	60	+20 / +10
	70	744			780		706/693			1563			
	80	844			880		806/818			1763			
	90	944			980		906/943			1963			
	100	1044			1080		1006/-			2143			
Sistem ALFA	60	648/610	1952	40	685/650	2015	465/425	1971	2043	750/713	-	-	+20 / +10
	70	748/735			785/775		565/550			850/838			
	80	848/860			885/900		665/675			950/963			
	90	948/985			985/1025		765/800			1050/1088			
	100	1048/-			1085/-		865/-			1150/-			
Sistem BETA	60	592/554	1945	40	685/650	2015	455/415	1971	2043	750/713	-	-	+20 / +10
	70	692/680			785/775		555/540			850/838			
	80	792/806			885/900		655/665			950/963			
	90	892/930			985/1025		755/790			1050/1088			
Sistem OMEGA	2 x 90	648/610	1911	30	1370/1275	2015	644/606	1909	2043	1429/1337	-	-	+20 / +10
	2 x 70	748/735			1570/1525		744/731			1629/1587			
	2 x 80	848/860			1770/1775		844/856			1829/1837			
	2 x 90	948/985			1970/2025		944/981			2029/2087			
	2 x 100	1048/-			2170/-		1044/-			2229/-			
Sistem de glisare KOMPAKT - simplu	60	644	1985	40	670	2030	609	1973	2045	1355	2083	-	+10 / +5
	70	744			770		709			1555			
	80	844			870		809			1755			
	90	944			970		909			1955			
	100	1044			1070		1009			2155			
Sistem de glisare KOMPAKT - dublu	2 x 50	644	1985	40	1288	2030	1234	1973	2045	2613	2083	-	+10 / +5
	2 x 70	744			1488		1434			3013			
	2 x 80	844			1688		1634			3413			
	2 x 90	944			1888		1834			3813			
	2 x 100	1044			2088		2034			4213			

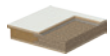
NOTĂ: *două (DIN) sau trei (standard ceh) balamale cu știft incluse în prețul canaturilor de interior; **golul de zid pentru caseta pregătită pentru montajul tocului.

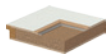
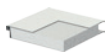
Tipuri de construcție

	MIEZUL								CU/FĂRĂ FALȚ	
										
	structura de stabilizare	fagure de stabilizare	PAL perforat	PAL plin	PAL plin cu elemente din placaj	lemn stratificat	construcție stratificată	construcție ramă cu panou	fără falț	cu falț
Minimax	○	●	●	○	○	○	○	○	○	●
Londra, Viena	○	●	○	○	○	○	○	○	○	●
Porta ROYAL	○	●	○	○	○	○	○	○	○	●
Porta DECOR	○	●	●	○	○	○	○	○	●	●
Porta GRANDE	○	○	○	○	○	●	○	○	●	●
Porta VECTOR	○	●	●	○	○	○	○	○	●	●
Porta TWIST	○	●	○	○	●	○	○	○	●	●
Porta GRANDEDECO	○	●	■	○	■	○	○	○	●	●
Porta STIL	○	●	●	○	■	○	○	○	●	●
Porta PASKY	○	●	●	○	○	○	○	○	●	●
Porta FOCUS	○	●	●	○	○	○	○	○	●	●
Porta FIT	○	●	●	○	■	○	○	○	●	●
Porta NOVA	○	●	●	○	■	○	○	○	●	●
Porta LINE	○	●	●	○	○	○	○	○	●	●
Laminate CPL	○	●	●	○	■	○	○	○	●	●
Porta CONCEPT	○	○	○	○	○	●	○	○	●	●
Porta ADMIRE	○	○	○	○	○	○	○	●	○	●
Porta INSPIRE	○	○	○	○	○	●	○	○	●	●
Porta OFFICE	○	●	●	○	○	○	○	○	○	●
Porta CLASSIC	○	○	●	○	○	○	○	○	●	●
Natura FAVORITE	○	○	○	○	○	●	○	○	●	●
MALAGA	○	○	○	○	○	○	●	○	●	●
Madrid, Cordoba	○	○	○	○	○	○	●	○	●	●
Toledo, Sevilla	○	○	○	○	○	○	●	○	●	●
Nova NATURA	○	○	●	○	○	○	○	○	●	●
Nova NATURA TOP	○	○	○	●	○	○	○	○	●	●
Natura LINE	○	○	●	○	○	○	○	○	●	●
Natura SPACE	○	○	○	○	●	○	○	○	●	●
Natura TREND	○	○	○	○	○	●	○	○	●	●
Natura CONCEPT	○	○	○	○	○	●	○	○	●	●
Natura IMPRESS	○	○	●	○	○	○	○	○	●	○
Villadora RETRO	○	○	○	○	○	●	○	○	○	●
Villadora MODERN	○	○	●	○	○	○	○	○	●	○
Alfa, Beta	○	●	●	○	○	○	○	○	—	—
Omega	●	○	○	○	○	○	○	○	—	—

	MIEZUL								CU/FĂRĂ FALȚ	
										
	PAL perforat	placă PAL perforat + placă de aluminiu	placă PAL + placă de aluminiu	placă PAL perforat + bare de oțel + placă de aluminiu	placă PAL stratificat + placă de aluminiu	miez termoizolant triplustratificat	miez termoizolant în cinci straturi	miez termoizolant B (U = 1,7 W/m² K)	fără falț	cu falț
ENTRO	●	○	○	○	○	○	○	○	○	●
AGAT	○	●	○	○	○	○	○	○	○	●
OPAL	○	●	○	○	○	○	○	○	○	●
QUARTZ	○	○	○	○	●	○	○	○	○	●
GRANIT	○	○	○	●	○	○	○	○	○	●
GRANIT PS	○	○	●	○	●	○	○	○	○	●
ROMA	○	○	○	○	○	●	●	○	○	●
GDYNIA	○	○	○	○	○	○	○	●	○	●
WROCLAW	○	○	○	○	○	○	○	●	○	●

LEGEND: ● disponibil ○ indisponibil ■ condiții speciale (mai multe informații pe pagina modelului)